

Accu-Tab® PowerBase® 3070AT by Axiall Corporation

Installation and Operating Instructions



STD 50

The PowerBase® 3070AT Chlorinator is

NSF-Listed for pool applications.

ONLY Axiall Corp. Accu-Tab® Blue SI
Tablets for commercial pool applications
are permitted for NSF installations.
Use of tablets will void NSF certification.

DANGER:

DO NOT MIX CHEMICALS!

The *PowerBase* 3070AT chlorinator system is designed for use with Axiall Corp. approved tablets only. Do not use Cal-Hypo tablets with stabilized chlorine or bromine products, or other sanitizing chemicals.

Rev 02-05-2021

Description

The *Accu-Tab PowerBase 3070AT* chlorination system incorporates an Axial chlorinator into a compact plug and play system. Included in the system is an integrated, level controlled solution tank and a centrifugal pump. The flow rate through the system is controlled by a manually adjusted valve located on the discharge of the pump. The solution tank level is controlled by a float valve. As solution is pulled from the tank, the float valve opens allowing water to flow to the chlorinator, contacting the tablets, and then draining into the solution tank.

Overflow protection is standard. Two level switches in the top area of the Solution Tank (4" apart) will flip a relay in the electrical box causing the pump to turn on/off as needed.

The chlorination system is designed for use ONLY with Axial *Accu-Tab Blue SI* tablets utilizing the Axial erosion feeder technology that erodes only the bottom layer of tablets on the sieve plate, while keeping tablets above the sieve plate dry and ready for use. Tablets other than Axial *Accu-Tab Blue SI* tablets will have different delivery rates, resulting in improper chlorine delivery.



Installation Instructions

1. Place the chlorination system in a location near the place of application.
2. Level the system. This is important for proper chlorine delivery.
3. Connect the inlet flow meter assembly to the solution tank. The parts were shipped separately to prevent breakage in shipping.



4. Connect the inlet water supply with 1-1/2" PVC pipe or hose. Include an isolation valve in the line and the inlet filter.



5. Connect the discharge assembly to the pump using a section of 1-1/2" pipe. (The parts were shipped loose to prevent breakage in shipment.)
6. Connect the discharge piping from the feeder to the chlorine application point with 1-1/2" PVC pipe or hose. Include an isolation valve in the line.
7. Plug the power cord into an 120v receptacle.



8. If a chemical controller is utilized, plug the controller cord into the controller's 120v switched output.

NOTE: IF A HIGH PRESSURE WEBTROL PUMP IS ORDERED, A LARGER CAPACITY PUMP CONTACTOR IS INSTALLED IN THE ELECTRICAL BOX AND NO CORD/PLUG IS PROVIDED AS A 25 AMP CIRCUIT IS REQUIRED.

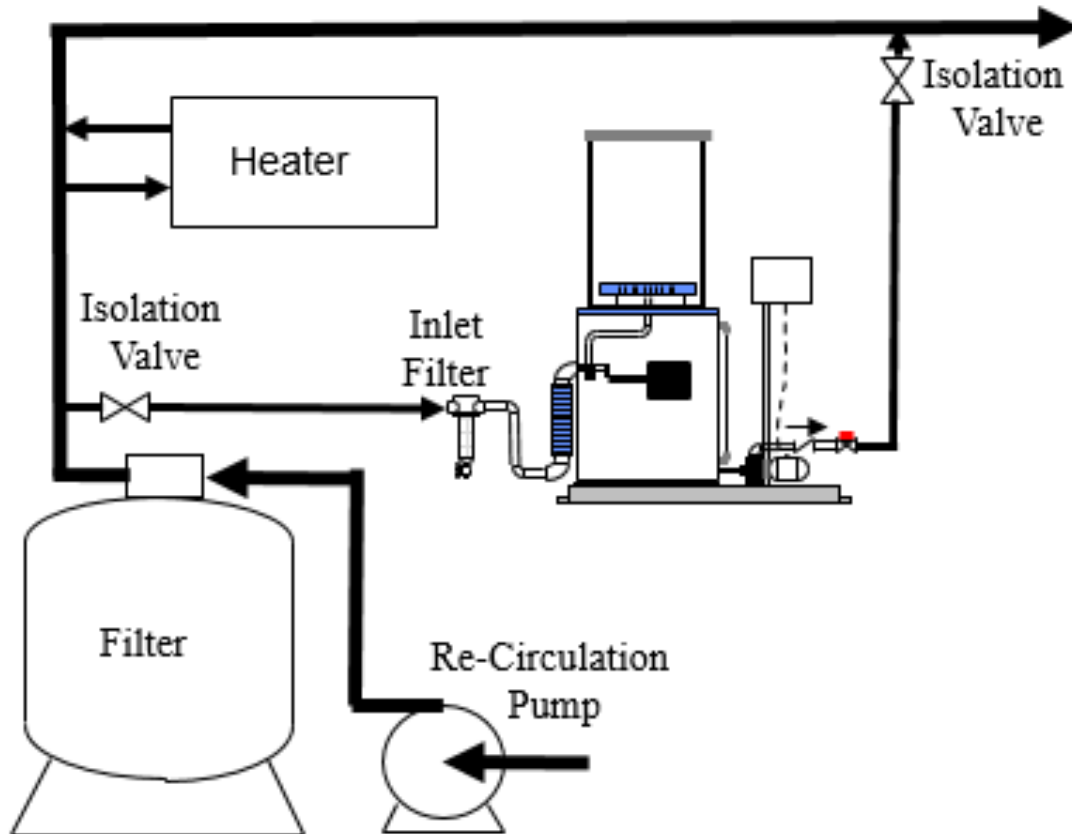

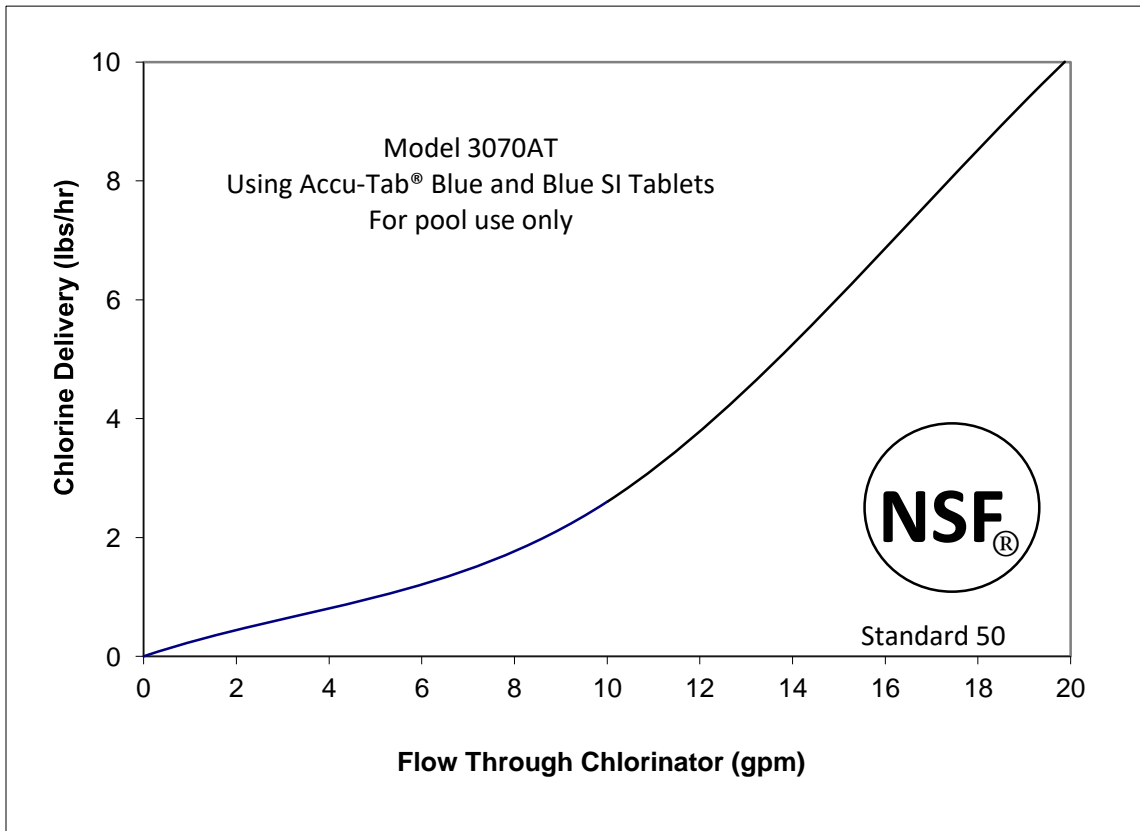

Start Up

1. Close the discharge gate valve.
2. Open the feed and discharge isolation valves. Water will begin to fill the solution tank.
3. When water stops flowing, switch the system "ON" using the chemical controller. The pump will circulate water through the black tubing.
4. Begin opening the discharge gate valve to start flow in and out of the system.
5. Determine the maximum inlet flow rate by continuing to open the discharge gate valve in small increments. Remember to allow a few minutes each time to allow the flow meter to stabilize. If pump loses prime, maximum inlet flow has been exceeded. Shut down system for a few minutes (which will prime the pump), close back on the discharge gate valve and restart the system. Continue this process until the maximum inlet flow is determined.
6. Adjust flow through feeder using the discharge gate valve. The chlorine delivery is determined by the flow rate through the chlorinator. Use the graph above to determine proper flow rate. NOTE: After adjusting the discharge valve, the flow meter will take a few moments to stabilize.
7. Check all piping for leaks.

Operation

1. Remove lid from chlorinator and fill with the appropriate amount of *Accu-Tab* Blue SI tablets. Add no more than the amount of tablets that will be used within one week.
2. Check pool water for desired chlorine level and adjust flow through chlorinator as needed.

NOTE: When pool water circulation stops, flow to chlorinator will stop. This will stop chlorine delivery.

WARNING: Overdosing of free chlorine can lead to bather irritation (skin, eyes, nasal, etc.).

Adding Tablets

1. Tablets may be added while the system is running. Take care to protect eyes, skin, clothing and other equipment from splashing. Do not inhale fumes.
2. Remove lid and add *Accu-Tab* Blue SI tablets.
3. Replace lid.

Maintenance

Clean the Check Valve and Float Valve at least every 4-6 months, or as needed, to remove scale or debris

Winterizing

1. Clean chlorination system following instructions below.
2. Close inlet isolation valve and operate pump until no more water can be pumped out.
3. Shut system down and close the outlet isolation valve.
4. Siphon any remaining water from the solution tank.
5. Remove any debris from the chlorinator or solution tank.
6. Open the bottom drain on the pump.
7. Drain water from feed and discharge lines.
8. Make sure no water remains in the pump, chlorinator, pipe line, or solution tank to prevent freezing over the winter.

System Cleaning

Over time the chlorination system may develop a build-up of scale. This should be cleaned on a periodic basis, up to twice per year. If scale formation is severe, more frequent cleanings may be necessary. Cleaning may be accomplished by soaking the chlorinator with a dilute acid solution according to the instructions below.

NOTE: Addition of muriatic acid may lower the pH of the pool water

Preparation for cleaning

1. Prepare 2 gallons of muriatic acid.
2. **Always use** appropriate safety equipment while servicing the unit or handling chemicals.
3. Clean the feeder in a well-ventilated area. Chlorine gas may be released during the cleaning process!

Inlet/Outlet Bypass

To facilitate the cleaning process a Bypass may be installed between the inlet and outlet lines to/from the chlorination system. Isolation valves at the recirculation line are required.

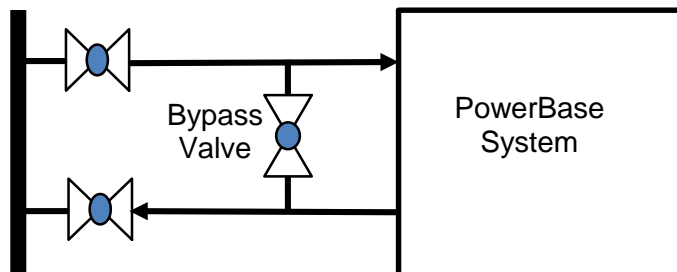

Cleaning procedure

1. Turn system off.
2. Open lid and remove all tablets. Use proper protective equipment when handling chemicals.
3. Switch system on to begin flushing the system.
4. Wash out the feeder with a hose to remove remnants of tablets and loosen scale.
5. Operate system until normal solution tank level is achieved. Switch system off.
6. Close inlet and outlet isolation valves and open inlet/outlet Bypass valve (if installed).
7. Very carefully, pour the acid into the upper chlorinator to dissolve scale. It may be necessary to pour directly on the inside walls to remove any scale above the water level. **Always add acid to water, never add water to acid.**
8. Let soak for 30 minutes. As acid dissolves scale, carbon dioxide will be released, and foaming will occur. If any tablets were left in the feeder, **chlorine gas may also be released.**
9. Turn system on to start acid circulation through the blue tubing. Circulate for 10 minutes.
10. Open all valves to begin purging acid from system. Shut Bypass Valve.
11. Wash the walls and sieve plate of the feeder with a hose to remove all acid residue. Chlorine gas may be released if any acid remains in the system.
12. Allow feeder to flush water for 30 minutes.
13. Turn system off. System is ready for operation.

Troubleshooting

System overflows.

1. Debris in the float valve.
2. Debris in the check valve.
3. Float valve stuck in down position. Clean float valve.

Pump will not run.

1. Check power supply and connections, and controller 110v signal.
2. Check for 110 voltage across terminals #2 and #5. If voltage present, wiring or pump motor failure.

Pump loses prime (solution tank drains)

1. Maximum inlet flow exceeded. See Start-Up instructions—point #5.

Float Valve maintenance

If valve becomes clogged with debris on a continuing basis, add a second filter to the inlet. Use the 60 mesh in the first filter then a 100 mesh in the second. The 100 mesh filter can be supplied by your specialist.

Chlorinator Top Orientation

Align the chlorinator top portion so that the pointer on the separation plate is directly over the inlet – see photo below. This will prevent chlorine solution from draining directly onto the float valve assembly.

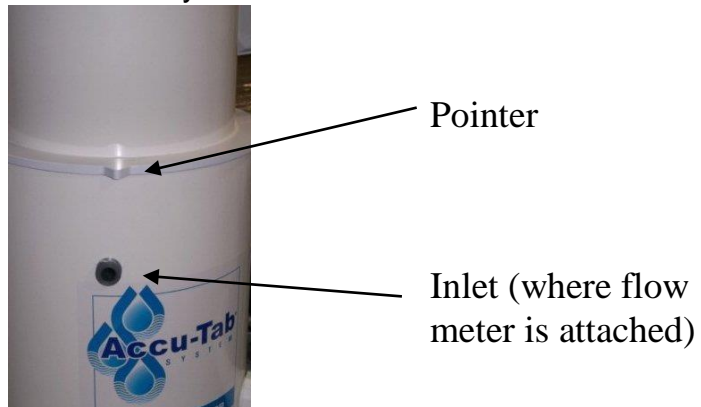

System Schematic

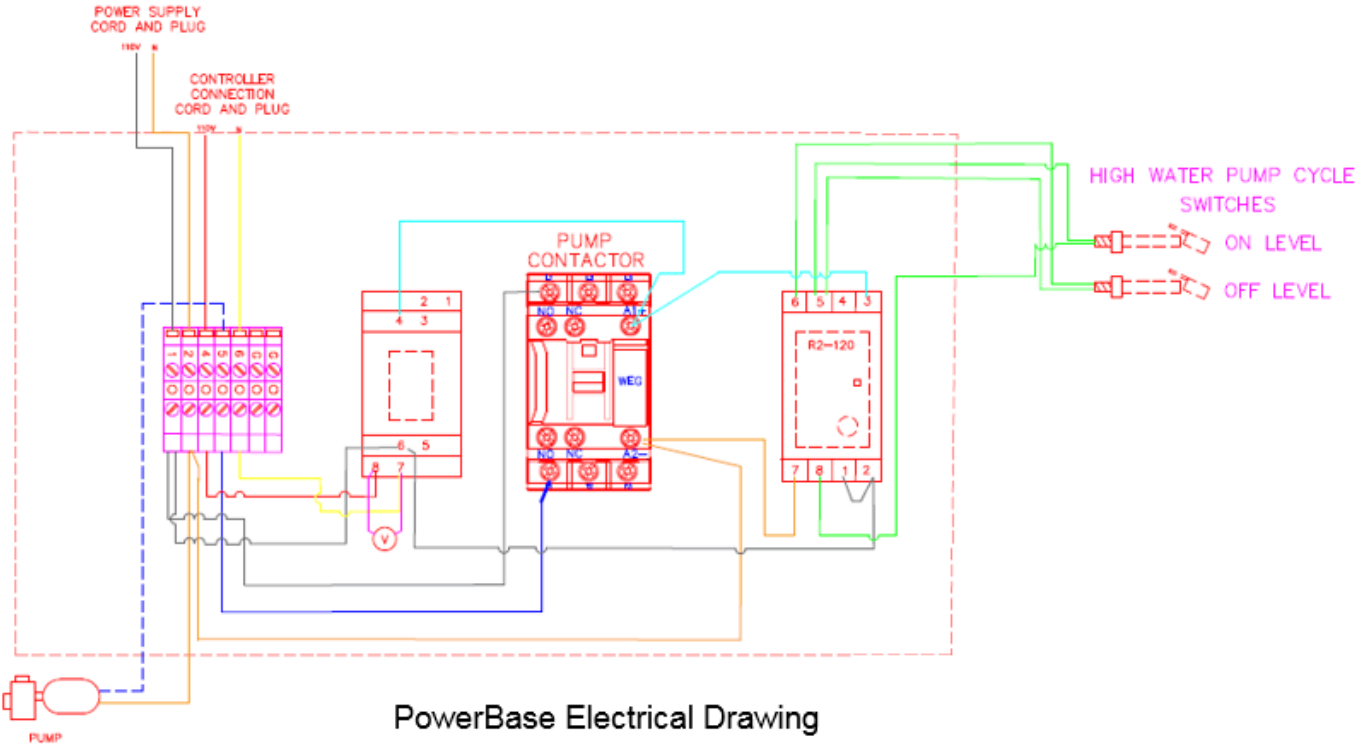
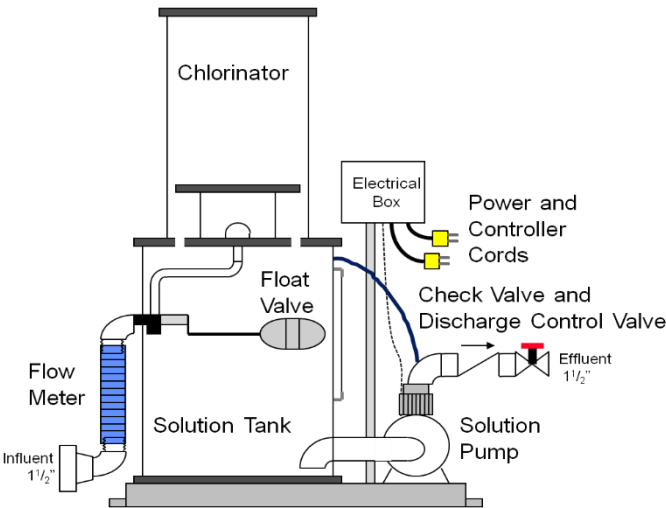

PowerBase Electrical Drawing

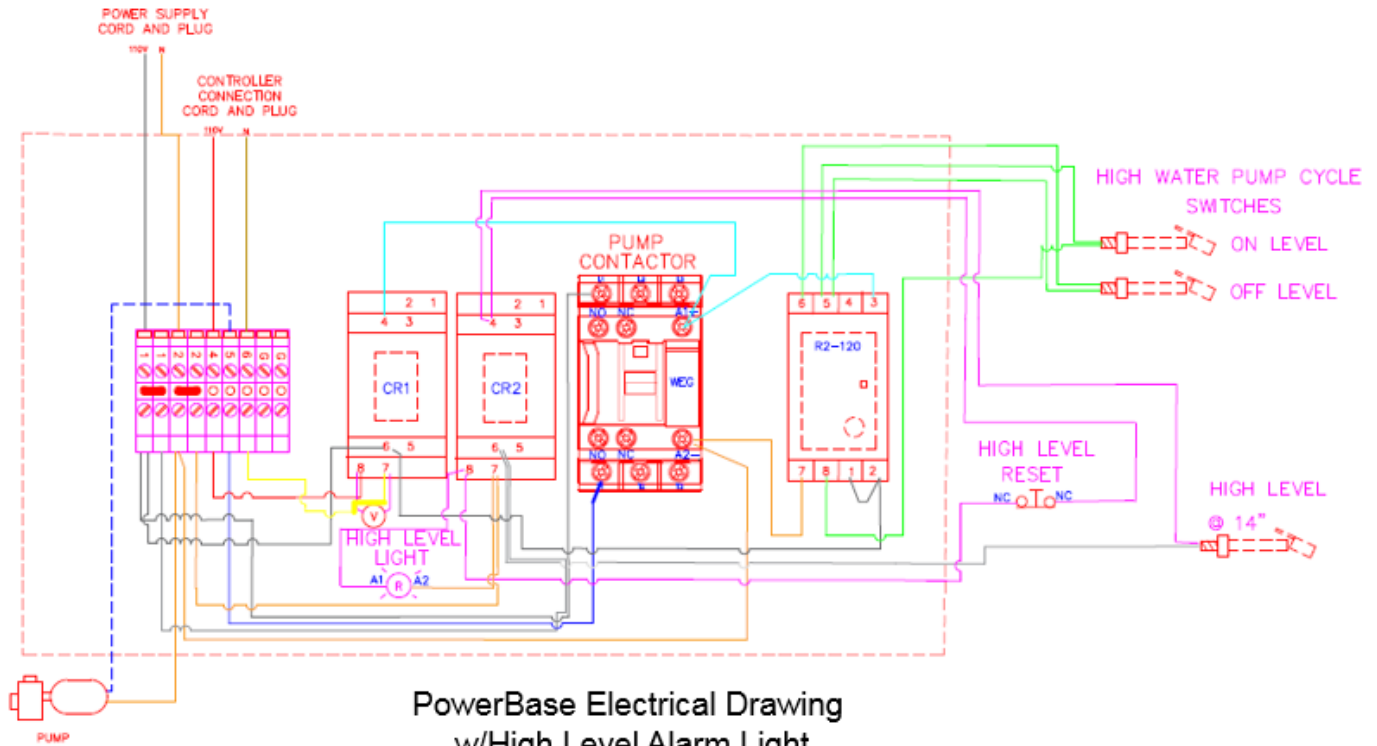

PowerBase Electrical Drawing
w/High Level Alarm Light

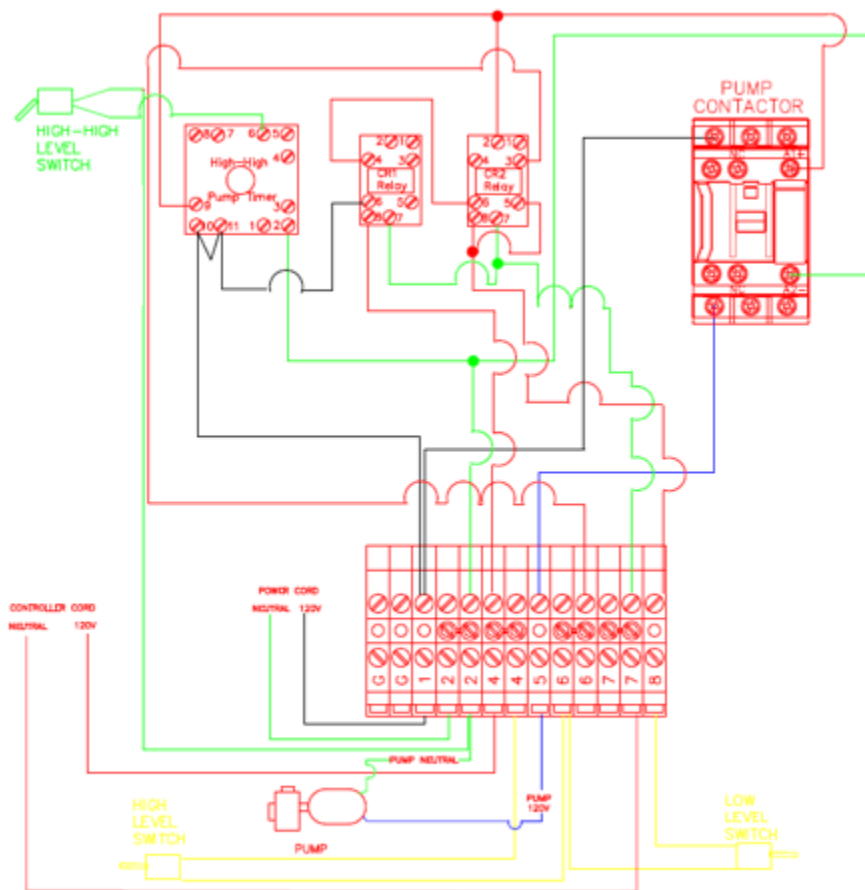

PowerBase HHL Electrical Drawing

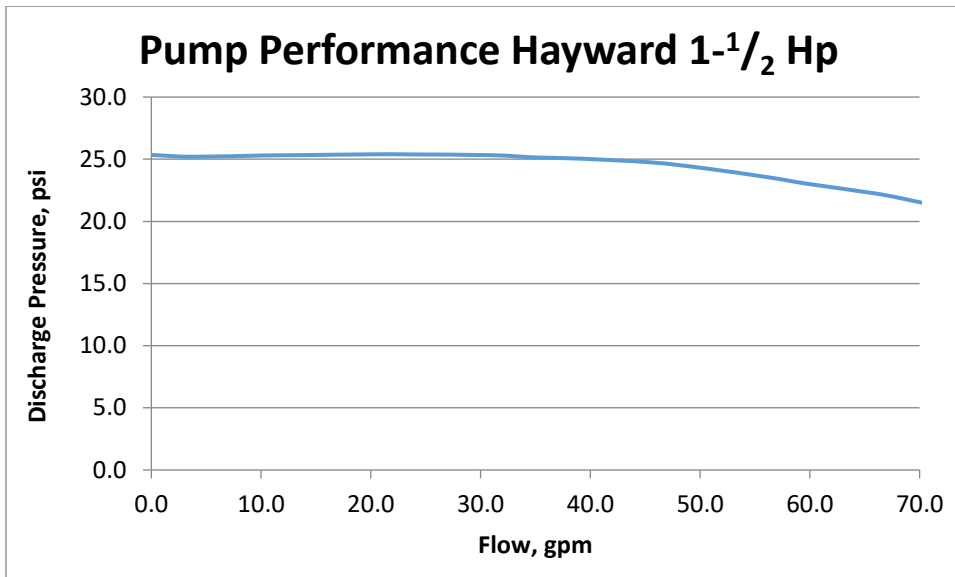

PurAqua Part #: PAPP1500

Pump Frame: R48Y

Amp rating: 15 amps

PowerBase Replacement Parts	PurAqua Part #	Axiall Part#
Hayward 1 1/2 HP Pump	PAPP1500	9500080
Seal for Hayward Pump	SPX1250XZ2C	
Webtrol 1 1/2 HP Pump	PC150R	9500185 Option
Seal for Webtrol Pumps	70X130-M	Option
Pump Contactor	NC1-1810-120V	9500145
1" Inline Flow Meter	F-41000LN-16	9500008
Level Switch	M8710	9500084
1 1/2" Discharge Swing Check Valve	S1720C-15	9500077
1" Gate Valve	GVG-1000-S	9500011
1 1/2" Inlet Filter	1-1/2-60-F	9500000
1" Kerick Float Valve	PS-100SS	9500007
R2-120	R2-120	

For other questions, contact Axiall Technical Service (855-934-3570) for assistance

CAL-HYPO COMMERCIAL SYSTEM LIMITED WARRANTY

Axiall, a Westlake Company ("Axiall") warrants (subject to the below conditions) only its title to this water treatment system equipment (the "System") and that the System will be free of defects in materials and workmanship for a period of eighteen (18) months from its original shipment date.

THIS IS THE ONLY REPRESENTATION OR EXPRESS WARRANTY THAT AXIALL MAKES AND ALL OTHER EXPRESS WARRANTIES UNDER STATUTE OR ARISING OTHERWISE IN LAW FROM A COURSE OF DEALING OR USAGE OF TRADE WITH RESPECT TO THE SYSTEM ARE DISCLAIMED. ANY IMPLIED WARRANTIES EXISTING AS A MATTER OF LAW SHALL NOT EXCEED THE DURATION OF THIS LIMITED WARRANTY. IN THE EVENT THE SYSTEM FAILS TO CONFORM TO THIS WARRANTY, AXIALL'S EXCLUSIVE OBLIGATION AND YOUR EXCLUSIVE REMEDY SHALL BE LIMITED TO, AT AXIALL'S OPTION, THE FURNISHING OF NEEDED REPLACEMENT PARTS OR THE FURNISHING OF A NEW SYSTEM (BUT THIS DOES NOT INCLUDE INSTALLATION OR THE COSTS FOR INSTALLATION). EXCEPT AS PROVIDED IN THE IMMEDIATELY PRECEDING SENTENCE, IN NO EVENT WILL AXIALL BE LIABLE UNDER ANY THEORY OF RECOVERY (WHETHER BASED ON NEGLIGENCE OF ANY KIND, STRICT LIABILITY OR TORT) FOR ANY DIRECT, INDIRECT, SPECIAL, INCIDENTAL, PUNITIVE, OR CONSEQUENTIAL DAMAGES IN ANY WAY RELATED TO ANY USE MADE OF THE SYSTEM.

Warranty Conditions. This Limited Warranty shall apply and be effective only if: (i) the System is installed and operated and maintained in accordance with this manual and the instructions accompanying the System; (ii) you, at your cost, promptly return the System or defective part to such location as may be specified by Axiall; and, (iii) only Axiall's Accu-Tab® Blue SI calcium hypochlorite tablets are used in the System. If any of these conditions are not met, this Limited Warranty will not apply and you acknowledge and agree that your purchase of the System will be on an "AS-IS" basis without any warranty of any kind whatsoever having been provided by Axiall.

You assume all responsibility and risk and liability arising from: (i) the unloading, installation, storage, handling and use of the System, including use thereof alone or in combination with other materials; (ii) the improper functioning or failure of unloading, installation, transportation or storage equipment you use, whether furnished or recommended by Axiall or not; and, (iii) the failure to comply with laws, rules and regulations governing storage, unloading, installation, handling, and use of the System. You will indemnify, hold harmless, and defend Axiall from and against any claim, suit, damage, cost, expense, fine, liability, or cause of action whatsoever, including reasonable attorney fees, on account of relating to, or arising out of the use, possession, installation or resale of the System.

This Limited Warranty gives you specific rights, and you also may have other rights, which vary from jurisdiction to jurisdiction. Some jurisdictions do not allow the exclusion or limitation of incidental or consequential damages, so the above limitations or exclusions may not apply to you. Some jurisdictions do not allow limitations on how long an implied warranty lasts, so the above limitation may not apply to you.